

**FREQUENTLY
ASKED QUESTIONS
AND ANSWERS
IN THE AREA OF
OROFACIAL
MYOFUNCTIONAL
THERAPY**



Orofacial Myofunctional Therapy is an interdisciplinary practice that works with the muscles of the lips, tongue, cheeks and face and their related functions (such as breathing, sucking, chewing, swallowing, and some aspects of speech). It acts in the prevention, evaluation, diagnosis and treatment of people who may have these functions compromised or altered. It can also act in improving facial aesthetics. In this area, the Specialist in Orofacial Myofunctional Therapy can work in partnership with other professionals such as dentists, doctors, physical therapists, occupational therapists, nutritionists, nurses and psychologists. As an emerging field, questions are quite common when we talk about Orofacial Myofunctional Therapy. Below are some answers of frequently asked questions.

ON THE FOLLOWING PAGES, WE HAVE COMPILED THE MOST
IMPORTANT QUESTIONS AND ANSWERS THAT PEOPLE ASK ABOUT
OROFACIAL MYOFUNCTIONAL THERAPY >

WHAT IS OROFACIAL MYOFUNCTIONAL THERAPY (OMT)?

Orofacial Myofunctional Therapy is neurological re-education exercises to assist the normalization of the developing, or developed, craniofacial structures and function. It is related to the study, research, prevention, evaluation, diagnosis and treatment of functional and structural alterations in the region of the mouth (oro), face (facial) and regions of the neck (oropharyngeal area).

WHAT ARE THE MAIN PROBLEMS RELATED TO OROFACIAL MYOFUNCTIONAL DISORDERS (OMDS)?

The main problems related to OMDs are alterations in breathing, sucking, chewing, swallowing and speech, as well the position of the lips, tongue (including what is known as oral rest posture), and cheeks.

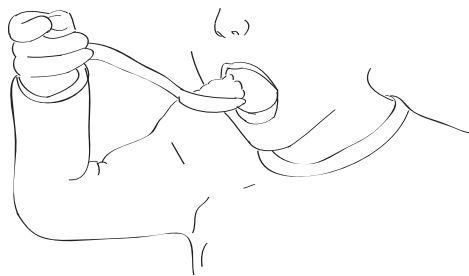

WHAT IS THE LINK BETWEEN FEEDING AND SPEECH?

Feeding a child stimulates the orofacial muscles and this promotes the growth of the face. In the same way, proper suction and chewing prevents dental alterations and difficulties when structures such as the lips and tongue are moving. This is fundamental in the production of speech sounds.



WHAT ARE THE ADVANTAGES OF BREAST-FEEDING?

Besides all the nutritional and immunological benefits, the practice of breastfeeding stimulates the proper functioning of the structures of the mouth and face. Breast feeding strengthens the orofacial muscles of the infant, reducing risk of future problems in important functions such as breathing, chewing, swallowing and speaking.

WHY SOME INFANTS HAVE DIFFICULTY SUCKING?

Difficulties of sucking in infants may occur due to: lack of sucking reflexes which decrease the suction force, frenulum restriction, lack of coordination between the actions of sucking, swallowing and breathing; improper positioning of the mother and/or the baby; absence of sealing (closing) of the lips around the breast nipple, and inadequate movement of tongue and jaw during breast feeding.

WHAT TO DO WHEN BREASTFEEDING IS NOT POSSIBLE?

Failing to breastfeed the infant directly at the maternal breast, milk may be collected from the mother's breast, or other milk may be recommended by a pediatrician, which also may be offered by a bottle, a spoon or a small cup. The evaluation of a specialist in Orofacial Myofunctional Therapy, with advanced training in this area, must be individualized in each case, and may assist in indicating the most appropriate way to breastfeed the infant, along with a lactation consultant.

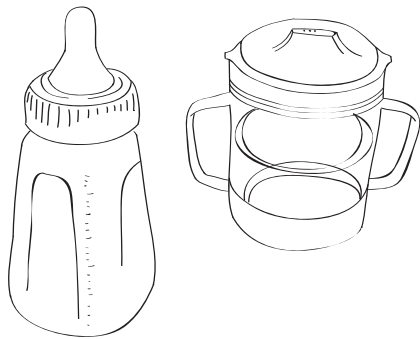

HOW TO FEED A BABY WITH CLEFT LIP AND PALATE?

For breastfeeding infants with a cleft lip, the guidelines are the same as given to infants without clefts. Many babies with a cleft lip may breastfeed with no alterations. However, in cases with a cleft palate, many children may fail to have an adequate milk intake with breastfeeding alone. In these cases, the milk can be offered using special feeding bottles.



HOW CAN FINGER SUCKING AND PACIFIER USE HARM A CHILD?

Depending on the child's facial features, the intensity, frequency and the duration of these oral habits may cause changes in facial growth, alteration of tooth position (anterior open bite), problems in the orofacial muscles, impairment of breathing

functions, chewing, swallowing, and may also lead to slurred speech, such as an anterior lisp (placing the tongue between the teeth). The pacifier soothes the baby, because it satisfies the need to suck, but its use can be eliminated as soon as possible.

HOW CAN ONE SUPPRESS HABITS, SUCH AS FINGER SUCKING AND PACIFIER OVERUSE?

The first step is to understand how these habits began and why are they still occurring. The child must be understood and not ridiculed. Awareness is crucial to gain the cooperation of the child. Depending on the case, the Orofacial Myofunctional Therapy Specialist may indicate exercises for strengthening the orofacial muscles (especially the lips and tongue), and the balance of the stomatognathic functions (breathing, chewing and swallowing). An occupational therapist may also be indicated for consultation.

WHY DO SOME YOUNG CHILDREN LOVE TO EAT VERY SOFT FOOD?

The preference for soft foods may be related to the reduction of the strength of the muscles of mastication (chewing) and also because of enlarged tonsils. Some children prefer foods with such consistency, as they would not need to chew much or at all. Feeding early on with different consistencies may stimulate the strength of the orofacial muscles and enhance harmonious development of the face.

WHAT IS A LISP?

A lisp is a distortion of speech, characterized by placing the tongue between the front teeth during the production of the sounds /s/ and /z/.

CAN CHEWING ON ONE SIDE ONLY BE HARMFUL?

Yes it is. By chewing only on one side, only the muscles of one side of the face are emphasized. This can cause a facial asymmetry over time. In addition, the bite can be altered and the temporomandibular joint (TMJ, the joint that connects the jaw to the skull and allows the mouth to open and close) on the opposite side of mastication, may suffer an overload.

WHAT CAN CAUSE AN OPEN BITE?

An open bite corresponds to a problem of occlusion caused by multiple factors. Harmful habits (such as finger sucking or pacifier use) as well as the presence of functional disorders (such as mouth breathing and inadequate pressure for an optimal position of the tongue during swallowing and /or speech).

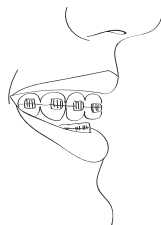

SHOULD OROFACIAL MYOFUNCTIONAL THERAPY OCCUR BEFORE OR AFTER ORTHODONTIC TREATMENT?

Orthodontic and Orofacial Myofunctional Therapy can be closely related with each directly impacting the other. Each case must be analyzed and discussed by the professionals involved. Treatment may be indicated before, during, and or after orthodontics. Orofacial Myofunctional Therapy specialists promote a balance of the muscle and orofacial functions, improving the oral rest posture of the tongue and thus the stability of these cases treated by orthodontists by helping diminish orthodontic relapse after the removal of braces.

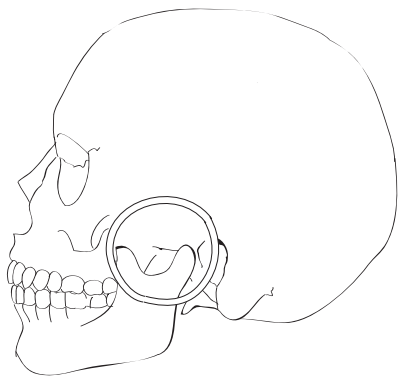

WHAT IS TEMPOROMANDIBULAR JOINT DYSFUNCTION?

The term temporomandibular dysfunction (TMD) is used to define some problems that can affect the temporomandibular joint (TMJ), as well as muscles and structures involved in chewing.

WHAT CAUSES TMD?

TMD may be related to various factors such as dental changes (loss or wear of the teeth, poorly fitting dentures), unilateral chewing, mouth breathing, lesions due to trauma or degeneration of the TMJ, muscle strains caused by psychological factors (stress and anxiety) and poor habits (nail biting, biting objects or food too hard, resting a hand on the chin, grinding or clenching teeth during sleep).

WHAT ARE THE MAIN SIGNS AND SYMPTOMS OF TMD?

Pain may be present around the TMJ (it may radiate to the head and neck), along with earache, tinnitus, ear fullness, sounds when opening or closing the mouth (popping or other noises in the TMJ), pain or difficulties when opening the mouth, and pain when moving the jaw and the muscles involved in chewing.

HOW IS OROFACIAL MYOFUNCTIONAL THERAPY CARRIED OUT FOR PATIENTS WITH TMD?

Most cases of TMD should be treated by a team of allied health professionals such as an Orofacial Myofunctional Therapy Specialist, dentist, psychologist, physical therapist, neurologist and otolaryngologist. The Orofacial Myofunctional Therapy Specialist, after conducting a thorough assessment, working in an allied approach, may apply techniques to rebalance the muscles of the mouth, face and neck, and restore the functions of breathing, chewing, and swallowing. With this, there may be attenuation and/or elimination of the signs and symptoms of TMD. The patient should be made aware about any harmful oral habits and oriented to contribute to the evolution of its clinical case.

WHO CAN PROVIDE OROFACIAL MYOFUNCTIONAL THERAPY?

The stomatognathic system is supported by an interdisciplinary team including speech language pathologists, otolaryngologists, orthodontists, dentists, dental hygienists, physical therapists, occupational therapists, kinesiotherapists and others. Each country's healthcare system is different, with one specialty having differing degrees of leadership roles. In some countries speech pathologists may take a leading role where in others another profession such as physical therapy or dental hygiene may have a more prominent role. It's a truly interdisciplinary therapy, with several professions contributing, each according to their own scope of practice. It is incumbent upon the professional to complete additional training in orofacial myofunctional therapy and to abide to local laws in the country in which they reside.

WHAT CAUSES FACIAL PARALYSIS?

There are two types of facial paralysis: Peripheral Facial Paralysis, that affects the facial nerve (lesion outside the brain) and can be caused by trauma, tumors, infections or unknown factors, and Central (brain injury) caused by cerebral vascular accident (stroke), head injuries and brain tumors.

HOW ARE THE TWO KINDS OF FACIAL PARALYSIS DIFFERENTIATED?

In Peripheral Facial Paralysis, only one side of the face or the whole face is affected. In Central Facial Paralysis, only the lower region of the face (around the mouth and nose) is paralyzed. In the presence of a facial palsy or any facial paralysis, it is critical to seek medical advice, seeking a diagnosis and appropriate treatment.

HOW MAY AN OROFACIAL MYOFUNCTIONAL SPECIALIST WORK WITH PATIENTS WHO HAVE FACIAL PARALYSIS?

A specialist in Orofacial Myofunctional Therapy may work, with advanced training and according to their particular specialty's scope of practice, on the underlying muscles that may be involved. This work should be performed in conjunction with otolaryngologists and neurosurgeons. The main objective of the Orofacial Myofunctional Therapist is to rehabilitate the functions of chewing, swallowing, sucking and facial expression (essential to human communication). The muscles of the face are manipulated so that they can "relearn" the functions performed by them before the injury. The Orofacial Myofunctional intervention should be initiated as early as possible, in order to prevent muscle atrophy.



WHAT IS THE RELATIONSHIP BETWEEN OROFACIAL MYOFUNCTIONAL THERAPY AND FACIAL AESTHETICS?

Wrinkles and marks caused by facial expressions and habits that are directly linked to the function of the muscles of the face, which should be quite familiar to the specialist who works in Orofacial Myofunctional Therapy.

HOW ARE WRINKLES PRODUCED?

Wrinkles may be the result of inadequate postures, habits and repetitive movements, when chewing, swallowing, breathing and in speech. Furthermore, the wrinkles may be influenced by the exaggerated strain of the facial muscles.

HOW MAY THE OROFACIAL MYOFUNCTIONAL SPECIALIST WORK WITH FACIAL AESTHETICS?

The Specialist in Orofacial Myofunctional Therapy works with the functions of chewing, swallowing, and breathing. When these functions are working adequately and habits are eliminated, with the manipulation of the facial muscles, one may achieve a significant improvement in facial aesthetics with facial rejuvenation and smoothing of wrinkles.

zZZz...

zZZz...

zZZz...

WHAT IS SNORING?

Snoring is defined as partial obstruction of the upper airways causing noise and vibration produced by some muscles of the mouth and throat during sleep.

DOES SNORING CONTRIBUTE TO THE EMERGENCE OF OBSTRUCTIVE SLEEP APNEA?

Yes, due to constant vibration, the muscles of the mouth and throat become larger, and may bring about changes in size, width and thickness. This may contribute to the appearance of total or partial obstruction of breathing during sleep.

WHAT IS OBSTRUCTIVE SLEEP APNEA?

Obstructive Sleep Apnea Syndrome is defined as an obstruction of the airflow channel during sleep.

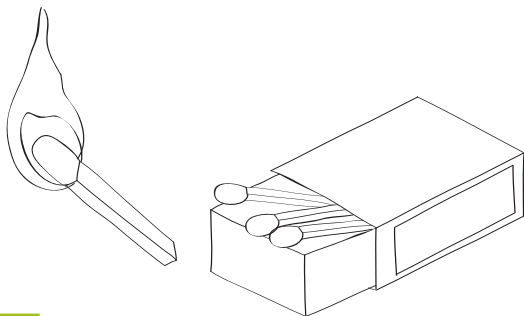

HOW COULD OROFACIAL MYOFUNCTIONAL THERAPY BE RELATED TO CASES OF SNORING?

Whoever snores and presents Obstructive Sleep Apnea should be treated by a multidisciplinary team including a sleep specialist. In this team, the Orofacial Myofunctional Specialist may help by directing and performing specific exercises to strengthen the muscles of the mouth and throat and exercises that may help, if indicated, in improving oral rest posture.

WHAT ARE POSSIBLE ISSUES AFFECTING PEOPLE WHO'VE SUFFERED BURNS ON THE FACE AND NECK?

Burns that affect the face and neck can trouble breathing, the act of opening and closing the mouth, chewing and swallowing. The aesthetics of the face is also affected.

HOW MAY OROFACIAL MYOFUNCTIONAL THERAPY HELP PATIENTS WHO HAVE SUFFERED BURNS IN THE FACE AND NECK?

A burned patient must be treated by a multidisciplinary team. Within this team, advanced specialists in Orofacial Myofunctional Therapy may help patients with third degree burns. In an initial period, the therapy aims to prevent scarring sequelae. In later periods, it seeks to improve the functions of breathing, chewing, speech, voice and swallowing, as well as reducing tissue retraction affected by burning (to promote balanced muscles of the face and neck and improve the aesthetics of the face).

AFTER BURNING THE FACE, WHEN SHOULD A PERSON SEEK OROFACIAL MYOFUNCTIONAL THERAPY?

After being evaluated and treated by a medical team and finding that the patient is clinically stable, they may now be evaluated by an Orofacial Myofunctional Therapy Specialist, with advanced training in this area, in order to help prevent the emergence of sequelae.

WHAT IS A FACIAL TRAUMA? WHAT ARE THEIR CAUSES?

The traumas and fractures caused on the face are called facial trauma. Traffic accidents, falls, assaults, accidents with firearms, among others, could cause trauma and fractures in various parts of the body, including the face.

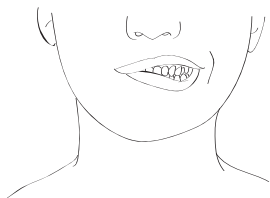

WHAT ARE THE POSSIBLE DIFFICULTIES PRESENTED BY PEOPLE WHO HAVE SUFFERED FACIAL TRAUMA?

Chewing and swallowing are the functions more impaired, because facial trauma is mainly comprised of damage to the facial muscles, teeth and bones of the maxilla and mandible. Thus, a change occurs in speech articulation and also in the opening and closing of the mouth during speech and chewing. The TMJ and the aesthetics of the face may also be impaired. Speech is in the domain of a Speech-Language Pathologist.

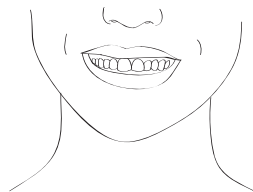

HOW MAY OROFACIAL MYOFUNCTIONAL THERAPY HELP PATIENTS WHO HAVE SUFFERED FACIAL TRAUMA?

Treatment of a patient who has suffered a facial trauma is multidisciplinary and specialized. The goal of the specialist in Orofacial Myofunctional Therapy is to promote the balance of the muscles of the face which may help to relieve pain, decrease swelling, improve chewing, speech, and the appearance of scars and facial aesthetics. Patients may also benefit from re-education of chewing, swallowing, and breathing patterns.

MOUTH BREATHING >

WHAT IS MOUTH BREATHING?

Mouth breathing refers to breathing performed predominantly by the mouth. In this way of breathing, the individual does not use, or uses very little, the nose to inhale and exhale the air.

CAN MOUTH BREATHING CAUSE DAMAGE?

Yes in several aspects, such as the mouth's and face's structures and their function, including sleep, feeding, learning, hearing and speech.

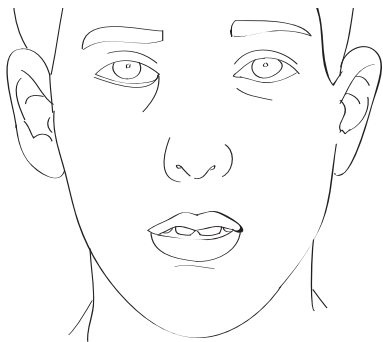

HOW CAN ONE IDENTIFY A PERSON WHO BREATHES THROUGH THE MOUTH?

The person may have one or more of the following characteristics: nasal congestion, open mouth at rest; parched lips, lip color change, appearance of a large tongue that may be recessed and projected forward; long face syndrome; forward head posture; dark circles under the eyes, sagging cheeks, wheezing, and snoring. In such cases it is recommended that an otolaryngologist (ENT) and/or allergist be consulted.

IS THERE A DIFFERENCE BETWEEN NASAL AND ORAL/MOUTH BREATHING?

Yes, when breathing is done through the nose, the air is filtered (cleaned), warmed and humidified, and thus it reaches the lungs with less impurities that are in the air. When you breathe through your mouth the air does not go through this process and reaches the lungs full of impurities. The oral rest posture of the tongue and the mandible when mouth breathing may also alter mandibular posture, palate width, and other craniofacial growth patterns as well as posture of the head, neck, and upper body.

WHAT CAN CAUSE MOUTH BREATHING?

The most common causes of mouth breathing are: allergic rhinitis, sinusitis, bronchitis, enlarged adenoids; enlarged tonsils; weakness or low tone of facial muscles that may lead to open mouth rest posture, habits such as thumb sucking, tumors in the region of the nose, enlarged turbinates, and nose fractures, amongst others.

HOW CAN MOUTH BREATHING CAUSE CHANGES TO THE STRUCTURE OF THE MOUTH AND THE FACE?

Keeping an open mouth posture can cause: dry and chapped lips, short and fast breathing; diminished strength of the muscles of the lips, cheeks, jaw and tongue; a lowered and more anterior oral rest posture of the tongue, leading to changes in aesthetics and position of teeth/occlusion (improper fit of the teeth); elongated face, retruded mandible, and palate (“roof of the mouth”) becoming more narrow and /or deep.

HOW CAN MOUTH BREATHING AFFECT FUNCTIONS RELATED TO THE MOUTH AND FACE?

Mouth breathing leads to chewing food with lips apart, which becomes faster, noisier and less efficient than with lips closed. This can lead to greater digestive problems and potential for choking due to the poor coordination between breathing, chewing, and an increase in the swallowing of air. It's hard to breathe through the mouth when the mouth is full, thus an individual will need to choose whether to chew or to breathe. In the

process of swallowing, one may also notice changes such as: anterior projection of the tongue, noise, contraction of muscles that wrap around the mouth and movements of the head. There may also be excessive production of saliva and an anterior lisp: which is a distortion of speech characterized by placing the tongue between the front teeth during sound production of /s/ and /z/.



WHAT ARE KEY ISSUES THAT MAY BE CAUSED BY MOUTH BREATHING DURING SLEEP?

When sleeping with the mouth open, a person may have some of these characteristics: restless sleep, snoring, headaches, drooling on the pillow, thirst when waking up, morning sleepiness, sleep apnea (breathing interruptions during sleep), and decreased oxygen saturation in the blood.

WHAT ARE DISADVANTAGES THAT MOUTH BREATHING MAY CONTRIBUTE WITH REGARDS TO FEEDING AND BODY WEIGHT?

Mouth breathers may have poor appetite, lower strength for chewing and swallowing difficulties. Thus they may prefer softer foods and the use of liquid to assist feeding. The feeding of mouth breathers may also be impaired because of decreased olfaction (smell) and taste (taste). As a result of changes in chewing, smell, and taste, the individual may have decreased appetite, gastric changes, constant thirst, gagging, pallor, anorexia, and weight loss with less physical improving or, conversely, obesity.

WHAT ARE THE MAIN DISADVANTAGES TO LEARNING CAUSED BY MOUTH BREATHING?

Sleep disturbances that have been previously explained can generate agitation, anxiety, impatience, decreased levels of alertness, impulsiveness and discouragement. All of these changes can cause difficulties with attention, concentration, memory problems, and subsequent learning difficulties in children. During the critical periods of a child's development, mouth breathing can be more detrimental to learning.

WHAT ARE THE MAIN DISADVANTAGES TO HEARING AND SPEECH CAUSED BY MOUTH BREATHING?

It is common in mouth breathing children to have more colds, infections in the nose, throat and chronic ear infections. Ear infection may lead to hearing loss, speech problems, language delays and vestibular issues. It is important to pay close attention to children in such cases: listen well to determine if they have difficulty hearing in the presence of noise; if they are unable to answer questions or follow direction, or could be considered inattentive. Most common changes are hoarseness in voice. This is because of the constantly open mouth leading to a drying out of all the structures that produce the voice and because the muscles are contracted for a long time, they may also appear to frequently have a cold and a runny nose.

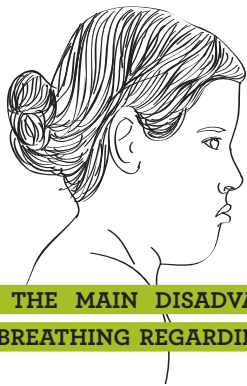

WHAT ARE THE MAIN DISADVANTAGES OF MOUTH BREATHING REGARDING BODY POSTURE?

One major alteration is a change in the head's postural position. The head will go forward seeking a larger space to breathe better, as often the tongue is resting in the floor of the mouth. We can also find other changes in the body caused by mouth breathing, as the abdominal muscles are weakened and stretched; dark circles with asymmetric positioning of the eyes, tired eyes, and shoulders that may come forward and compresses the abdomen.

WHICH KIND OF SPECIALIST IN OROFACIAL MYOFUNCTIONAL THERAPY SHOULD A MOUTH BREATHER SEEK?

An individual who breathes through the mouth can seek an Orofacial Myofunctional Therapy Specialist to assist in the treatment of mouth breathing, as any general Myofunctional Therapist is trained to deal with these cases, but some seek additional training in respiratory education techniques that may be helpful in treatment. Orofacial Myofunctional Therapy is commenced only after evaluation of the cause. It is advisable to also work within an allied team, with an otholaryngologist/ENT, a breathing specialist and /or an allergist as well.

LINGUAL FRENULUM >

WHAT IS TONGUE-TIE?

Tongue-tie is a popular term used to characterize a common condition that often goes undetected. It occurs during pregnancy when a small portion of tissue that should disappear during the infant's development remains at the bottom of the tongue, restricting its movement. When an infant is born with tongue-tie, it is important to research other family members, since this change has a genetic influence.

WHO CAN DETECT THE PRESENCE OF TONGUE-TIE?

A specialist in Orofacial Myofunctional Therapy should be well suited to detect a tongue-tie since they should know about the lingual frenulum and also the normal way the newborn sucks. In the case of infants, a pediatrician and a lactation consultant may also be involved.

MAY THE TONGUE AND FRENULUM BE INSPECTED AS SOON AS THE BABY IS BORN?

Yes, but there are varying degrees of tongue-tie, so the importance of having a test or validated protocol that evaluates the tongue and the “trickle” under the tongue (lingual frenulum) is crucial, as well as the way the infant sucks. This will ensure an accurate diagnosis, and indicate whether or not the need to do a frenotomy (or small “cut” under the tongue) is recommended.

HOW AND WHEN SHOULD TONGUE-TIE BE TREATED?

When the tongue cannot perform all the necessary movements and thus jeopardizes the way of sucking, swallowing, chewing or talking, a small surgery or frenotomy in the tongue is indicated. The “cut” of the frenum in infants is a simple procedure done with scissors, scalpel, or laser and anesthetic gel, which lasts about five minutes. In older children and adults the most common procedure is the frenectomy (partial removal of the lingual frenulum).

WHEN IS A SURGICAL PROCEDURE INDICATED TO RELEASE THE LINGUAL FRENULUM?

In infants, surgery is usually indicated when the lingual frenulum restricts the tongue's movement and compromises breastfeeding. In older children and adults, the indication is made when the tongue is visibly restricted, is unable to adequately reach the palate, or when possible distortions in speech are caused by limitation of the elevation of the tongue tip (especially in producing the sound of the "L" and "R") that could not be corrected in speech therapy. A lactation consultant may also be indicated for consultation.



WHAT CAN HAPPEN WITH AN INFANT IF NOT TREATED?

Many people with tongue-tie suffer the consequences without knowing the cause. There are infants who have changes in the feeding cycle, causing stress for the infant and for the mother; there are also children with difficulties in chewing, children and adults with speech problems affecting communication, social relationships and professional development. With the chronic oral rest posture of the tongue in the floor of the mouth, many of the Orofacial Myofunctional Disorders (OMDs) enumerated above may result.

This project, **FREQUENTLY ASKED QUESTIONS AND ANSWERS IN THE AREA OF OROFACIAL MYOFUNCTIONAL THERAPY**, is coordinated by

the Academy of Orofacial Myofunctional Therapy (AOMT), a USA based post graduate training institution that specialises in training allied health professionals in Orofacial Myofunctional Therapy. This pamphlet has been created with the support of the Brazilian Speech Pathology Society (Sociedade Brasileira de Fonaudiologia/SBFa) and their Orofacial Myofunctional Therapy Committee, upon whose original work, “*Repostas Para Perguntas Frequentes Na Area De Motricidade Orofacial*,” originally published in 2011, with a second edition in 2012. Brazil is the world’s leader in research, protocols, and standards in Orofacial Myofunctional Therapy and the SBFa has consistently been at the forefront. This project is also supported by the Academy of Applied Myofunctional Sciences (AAMS), an international, non-profit NGO and membership association engaged in advancing research, standards, education, and public health initiatives in the area of Orofacial Myofunctional Therapy worldwide.

SBFa LEADERSHIP 2012-2013

BOARD OF DIRECTORS

Irene Queiroz Marchesan_President
Ana Cristina Cortês Gama_Vice President
Lia Inês Marino Duarte_Secretary
Aline Epiphanio Wolf_Deputy Secretary
Ana Elisa Moreira-Ferreira_Treasurer
Adriana Tessitore_Deputy Treasurer
Marileda Cattelan Tomé_Scientific Director
Hilton Justino_Deputy Scientific Director

DEPARTMENT OF OROFACIAL MYOFUNCTIONAL THERAPY

Adriana Rahal_Coordinator
Andrea Motta_Deputy Coordinator

OROFACIAL MYOFUNCTIONAL THERAPY COMMITTEE

Daniele Andrade da Cunha_Coordinator
Carmen das Graças Fernandes_Deputy Coordinator

REVISION COMMITTEE 2012-2013

Ana Paula Dassie Leite
Ana Cristina Gama
Aline Wolf e Lia Duarte

TRANSLATION AND COPY UPDATES 2014 ACADEMY OF OROFACIAL MYOFUNCTIONAL THERAPY

Marc Richard Moeller
Licia Coceani-Paskay
Nicole Archembault Besson
Samantha Danielle Weaver

ILLUSTRATIONS

Luisa Furman

DESIGN

Lia Assumpção (Brazil)
Patrick Grandaw (USA)

© AOMT. All Rights Reserved. Reproduction requires the permission of the AOMT.

This is intended for information purposes only and should not be used to diagnose or treat. Any person seeking care should consult with their doctor prior to any form of treatment. AOMT disclaims any and all liability for the accuracy of the information presented and for any use of the information for any purpose.



**ACADEMY OF OROFACIAL
MYOFUNCTIONAL THERAPY**

910 Via De La Paz, Suite 106

Pacific Palisades, CA 90272, USA

www.aomtinfo.org

www.sbfa.org.br

www.aamsinfo.org

